

STAGE BEAMER RGB

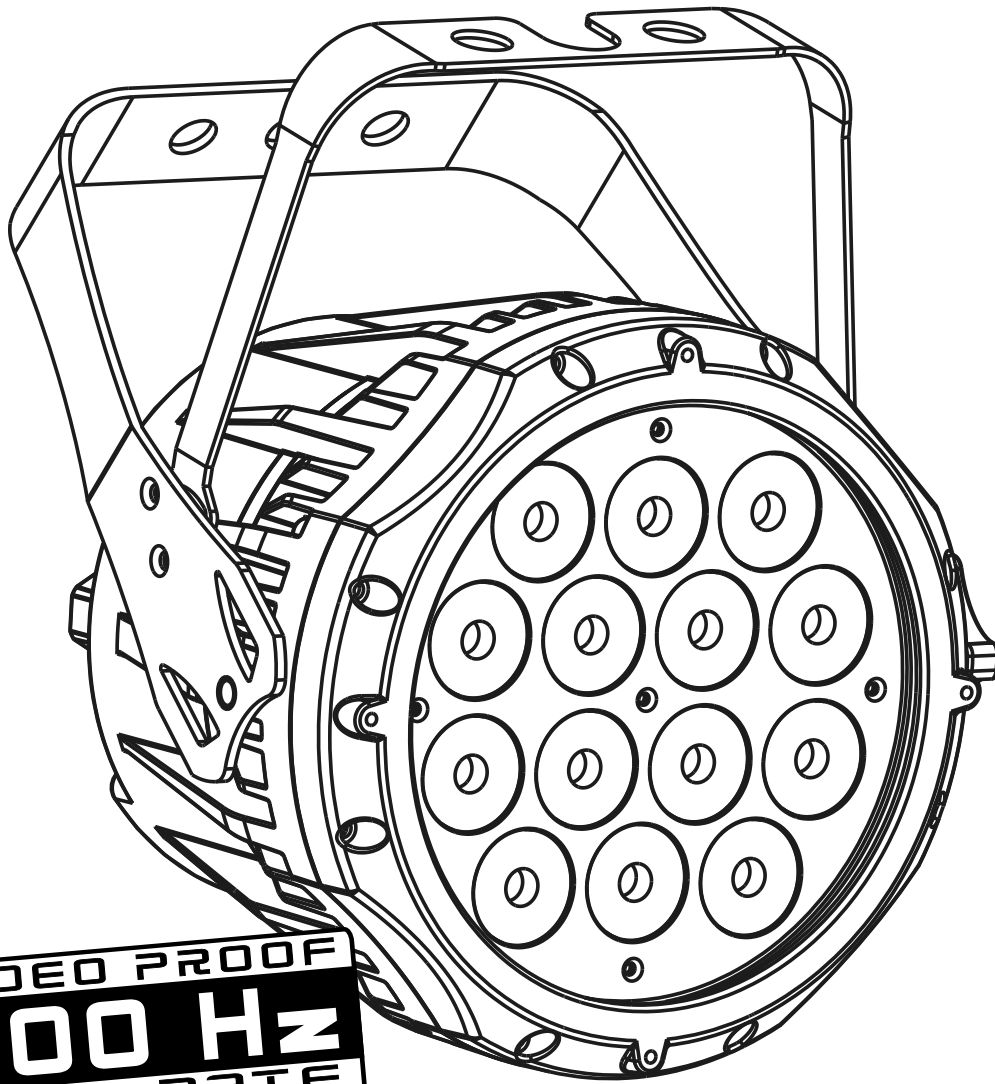

VIDEO PROOF
400 Hz
SCAN RATE

BriteQ[®]
LIGHT RESEARCH

USER
MANUAL
VER 1.0

WWW.BRITEQ-LIGHTING.COM

T ABLE OF CONTENTS

PART 1 PRODUCT (GENERAL)	1.
1.1-- <i>PRODUCT INTRODUCTION</i>	1.
1.2-- <i>PRODUCT FEATURES</i>	1.
1.3-- <i>TECHNICAL SPECIFICATIONS</i>	2.
1.4-- <i>PHOTOMETRIC DATA</i>	3.
1.5-- <i>SAFETY WARNING</i>	4.
PART 2 INSTALLATION	5.
2.1-- <i>MOUNTING</i>	5.
2.2-- <i>POWER CONNECTION</i>	5.
2.3-- <i>SETTING UP WITH A DMX512 CONTROLLER</i>	6.
2.3-1-- <i>DMX512 ADDRESSING WITHOUT ID ADDRESSING</i>	6.
2.3-2-- <i>DMX512 ADDRESSING WITH ID ADDRESS</i>	6.
PART 3 DISPLAY PANEL OPERATION	8.
3.1-- <i>BASIC</i>	8.
3.2-- <i>MENU</i>	9.
3.3-- <i>EDIT STATIC COLOUR</i>	10.
3.4-- <i>ACTIVATING AUTO PROGRAMS</i>	10.
3.5-- <i>RUN MODE</i>	10.
3.6-- <i>DMX512 SETTINGS</i>	11.
3.7-- <i>PERSONALITY</i>	11.
3.8-- <i>ID ADDRESS</i>	11.
3.9-- <i>EDITING CUSTOM PROGRAMS</i>	12.
3.10-- <i>SPECIAL SETTINGS</i>	12.
3.11-- <i>WHITES SETTING</i>	13.
3.12-- <i>WHITES BALANCE</i>	13.
3.13-- <i>ACTIVATE THE PASSWORD</i>	13.
PART 4 USING A DMX512 CONTROLLER	14.
4.1-- <i>BASIC ADDRESSING</i>	14.
4.2-- <i>CHANNEL ASSIGNMENT</i>	14.
4.3-- <i>BASIC INSTRUCTIONS FOR DMX512 OPERATION</i>	18.
PART 5 APPENDIX	19.
5.1-- <i>TROUBLE SHOOTING</i>	19.
5.2-- <i>MAINTENANCE</i>	20.

1 PRODUCT (GENERAL)

1.1 PRODUCT INTRODUCTION

This product is designed for indoor use. Suitable applications include wash or effect lighting for architectural, stage, theatre or road show applications. Direct input of DMX512 signal allows the units to be controlled from any DMX512 controller. This product can be operated as a single unit or in multiple units for large applications.

1.2 PRODUCT FEATURES

LED FIXTURE

- * RGB Dimmer 0-100%
- * Strobe
- * Built-in automatic programs
- * Upload custom parameters to slave fixtures
- * LED display
- * Display control 'lock-out'
- * Direct DMX512 input
- * Independent ID address
- * Different white colors setting
- * 'Over-heat' protection

1.3 TECHNICAL SPECIFICATIONS

LED MODULE

<i>LED MODULE:</i>	
Voltage	100~250V...50/60Hz
Rated Power	52W
LED/Unit	14 X 3W Tri-RGB
Environment Temperature	-20℃~40℃
Cooling	Direct air convection
Dimensions	245 x 205 x 245mm
Weight	4.8Kg

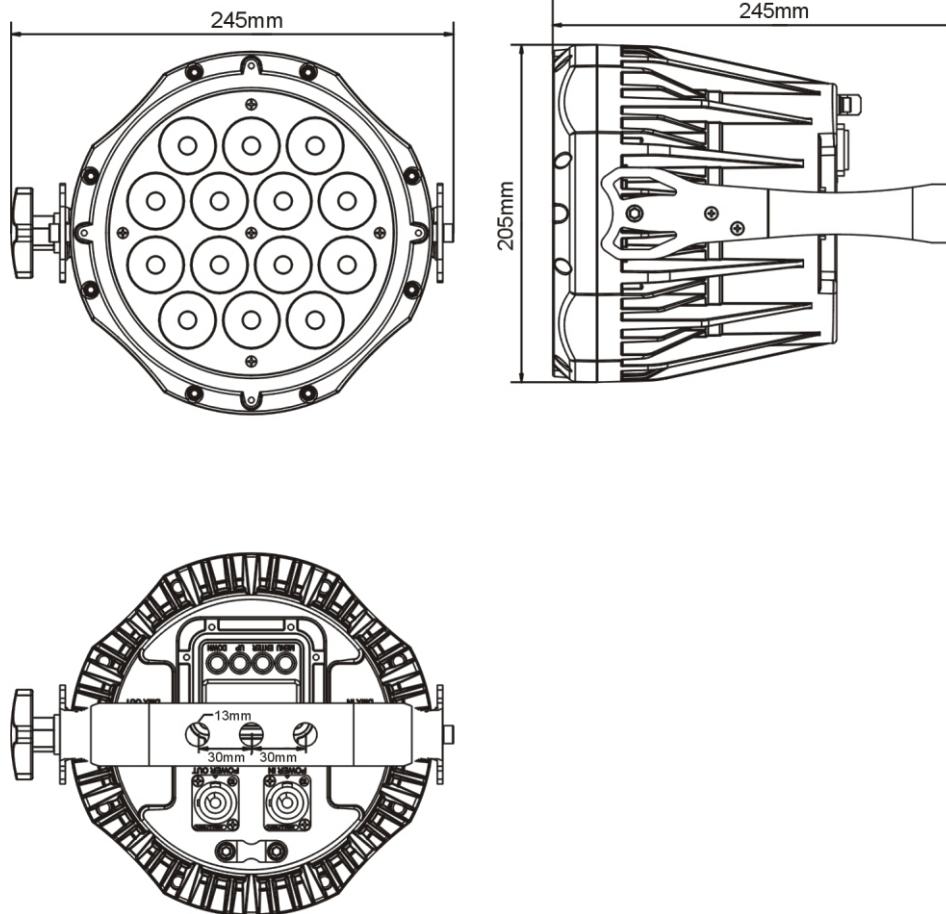

1.4 PHOTOMETRIC DATA

RED

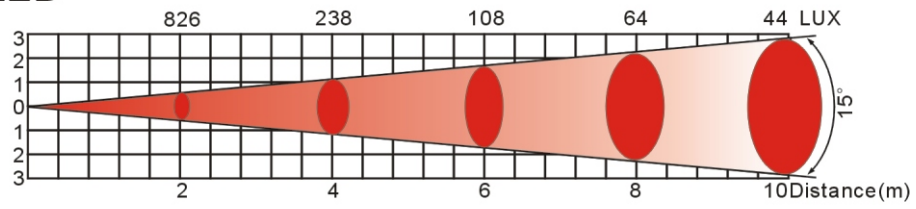

GREEN

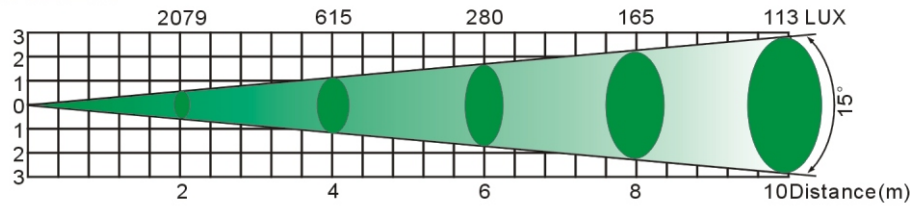

BLUE

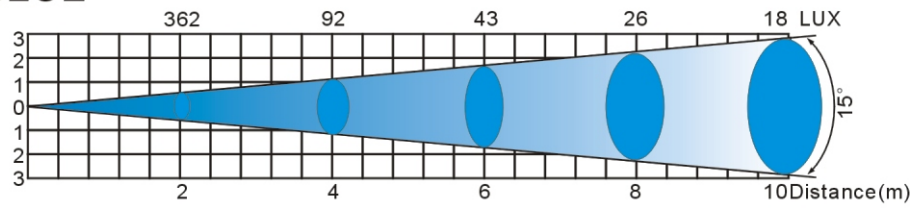

RGB

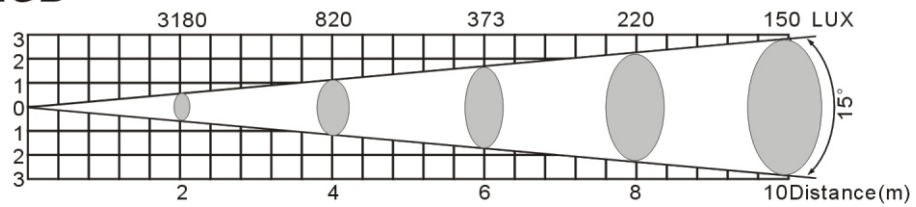

1.5 SAFETY WARNING

IMPORTANT

**【ALWAYS READ THE USER MANUAL BEFORE OPERATION. 】
【PLEASE CONFIRM THAT THE POWER SUPPLY STATED ON THE
PRODUCT IS THE SAME AS THE MAINS POWER SUPPLY IN YOUR
AREA.】**

- This product must be installed by a qualified professional.
- Always operate the equipment as described in the user manual.
- A minimum distance of 0.5m must be maintained between the equipment and combustible surface.
- The product must always be placed in a well ventilated area.
- Always make sure that the equipment is installed securely.
- DO NOT stand close to the equipment and stare directly into the LED light source.
- Always disconnect the power supply before attempting and maintenance.
- Always make sure that the supporting structure is solid and can support the combined weight of the products.
- The earth wire must always be connected to the ground.
- Do not touch the power cables if your hands are wet.

ATTENTION



- This product left the place of manufacture in perfect condition. In order to maintain this condition and for safe operation, the user must always follow the instructions and safety warnings described in this user manual.
- Avoid shaking or strong impacts to any part of the equipment.
- Make sure that all parts of the equipment are kept clean and free of dust.
- Always make sure that the power connections are connected correct and secure.
- If there is any malfunction of the equipment, contact your distributor immediately.
- When transferring the product, it is advisable to use the original packaging in which the product left the factory.
- Shields, lenses or ultraviolet screens shall be changed if they have become damaged to such an extent that their effectiveness is impaired.
- The lamp (LED) shall be changed if it has become damaged or thermally deformed.

2 INSTALLATION

2.1 MOUNTING

HANGING

The fixture can be mounted in a hanging position using the supporting bracket. The bracket should be secured to the mounting truss or structure using a standard mounting clamp. Please note that when hanging the unit a safety cable should also be used.

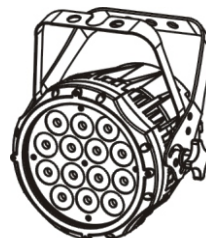

UPRIGHT

The fixture can be mounted in an upright or sitting position using the supporting brackets.

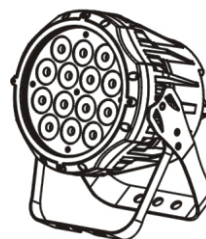

The LED MODULE can be mounted at any angle and in any position. It is possible to further adjust the angle of the LED MODULE using the two adjustment knobs located on the side of the fixture.

2.2 POWER CONNECTIONS

@ 220V: 24 units may be connected in series

@120V: 12 units may be connected in series

Note:

If the signal cable is over 60m between the DMX512 controller and fixture or between two fixtures, then a DMX signal amplifier is needed as well.

2.3 SETTING UP WITH A DMX512 CONTROLLER

2.3-1 **DMX512 ADDRESSING WITHOUT ID ADDRESSING (TOUR MODE)**

- Connect the DMX512 controller to the units in series.
- Each unit has 10 DMX channels so the DMX Addresses should increase by increments of 10 (e.g. 1,11,21,31...)
- The ID address has not been set so therefore when using the controller CH 10 must be inactive (CH10=0).
- It is also possible to deactivate ID address selecting **【ID OFF】** from the **【Settings】** menu. on the fixture
- Each DMX Address may be used as many times as required.
- Any DMX address in the range from 001 to 512 may be used.

Example:

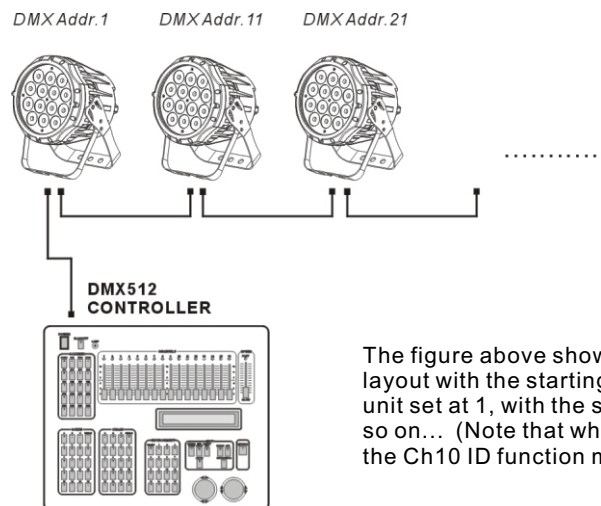

The figure above shows a simple DMX512 layout with the starting address of the first unit set at 1, with the second set at 11 and so on... (Note that when used in this way, the Ch10 ID function must be inactive (CH10=0))

2.3-2 **DMX512 ADDRESSING WITH ID ADDRESS (TOUR MODE)**

- Connect the DMX512 controller to the units in series
- Each unit has 10 DMX channels so the DMX Addresses should increase by increments of 10 (e.g. 1,11,21,31...)
- Each DMX Address may be used as many times as required.
- Any DMX address in the range from 001 to 512 may be used.
- Each DMX address may carry up to 66 separate ID addresses.
- **【ID】** should be set in the menu on each unit in ascending values (i.e. 1,2,3...)
- **【ID On】** should be set in the **【Settings】** menu on each unit.
- ID addresses are accessible from Ch10 on the DMX512 controller.

Example:

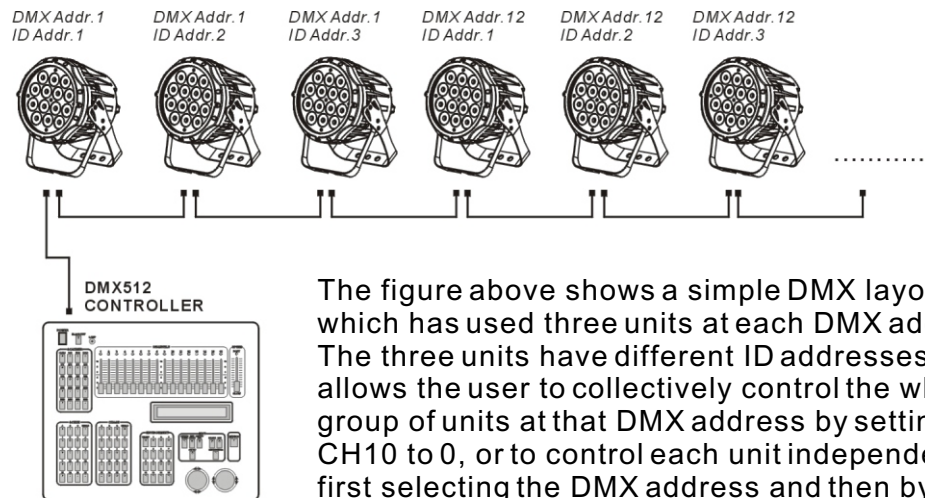

The figure above shows a simple DMX layout which has used three units at each DMX address. The three units have different ID addresses which allows the user to collectively control the whole group of units at that DMX address by setting CH10 to 0, or to control each unit independently by first selecting the DMX address and then by using Ch10 to locate the target ID address.

3 DISPLAY PANEL OPERATION

3.1 BASIC

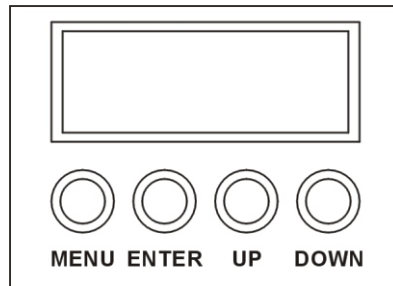

【 MENU 】 scroll through the main menu or return to the main menu

【 ENTER 】 enter the currently selected menu or confirm the current function value

【 UP 】 scroll 'UP' through the menu list or increase the value of the current function

【 DOWN 】 scroll 'DOWN' through the menu list or decrease the value of the current function

3.2 MENU

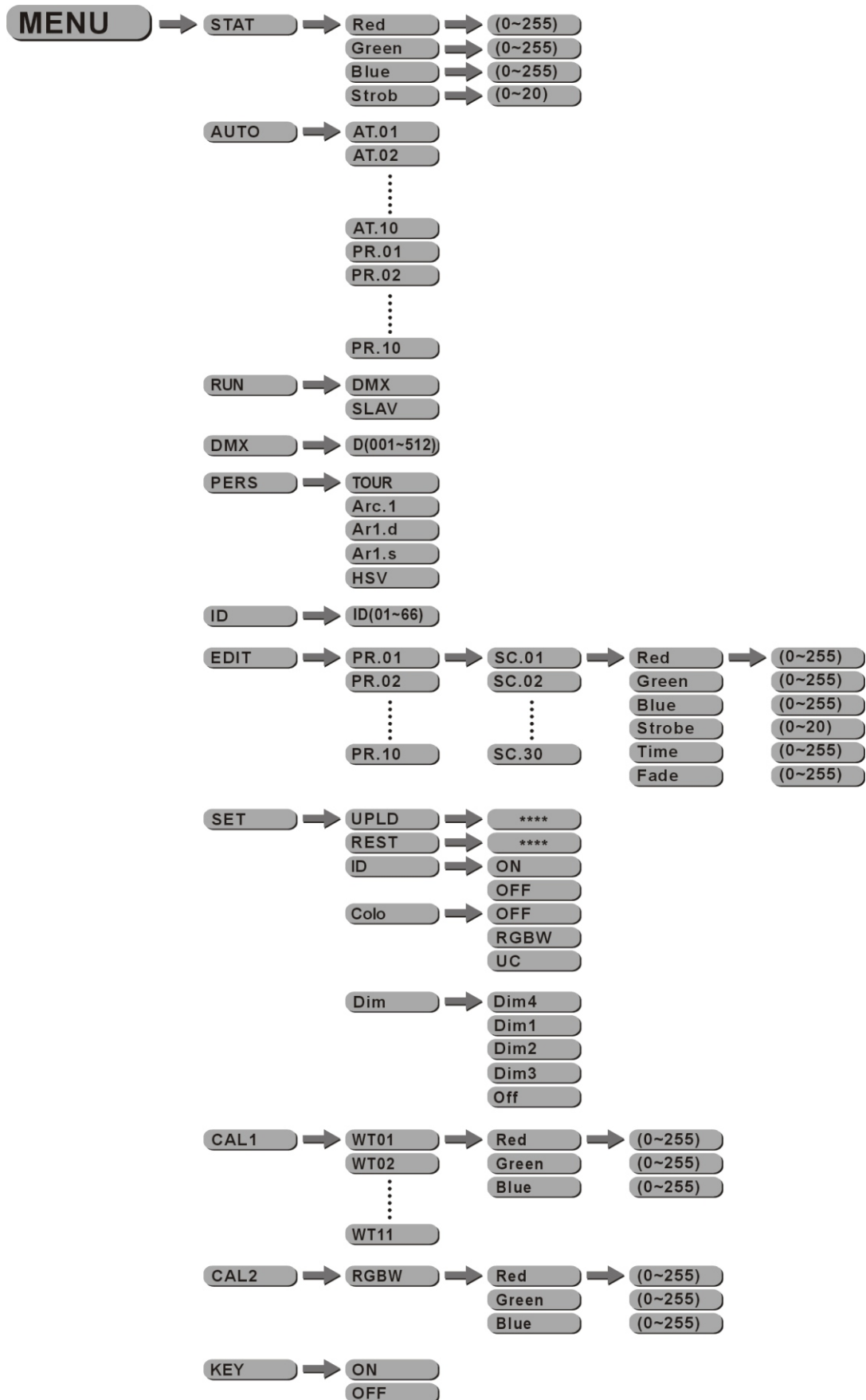

3.3 EDIT STATIC COLOUR



【STATIC COLOUR】

- Combine **【Red】** , **【Green】** & **【Blue】** to create an infinite range of colors (0-255)
- Set the value of the **【Strobe】** (0-20Hz)

3.4 ACTIVATING AUTO PROGRAMS

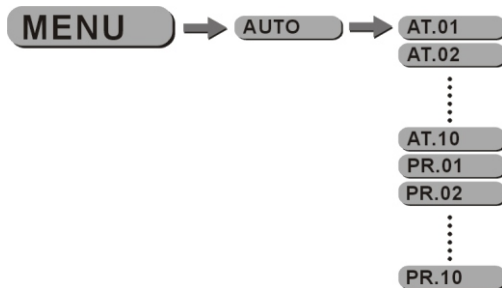

【AUTO】

- Select the target **【AUTO】** program and press **【ENTER】** .
- Programs **【AT.01】** to **【AT.10】** are fully pre-programmed and will not be altered by changes in **【EDIT】** mode.
- Programs **【PR.01】** to **【PR.10】** are fully pre-programmed and can be edited in **【EDIT】** mode.

3.5 RUN MODE



【RUN】

- Enter the **【RUN】** mode to set working mode.
- **【DMX】** mode is for using the DMX512 controller to control the fixtures.
- **【SLAV】** mode is for Master -- Slave operation.

3.6 DMX512 SETTINGS



【DMX】

- Enter the **【DMX】** mode to set the DMX ADDRESS.

3.7 PERSONALITY

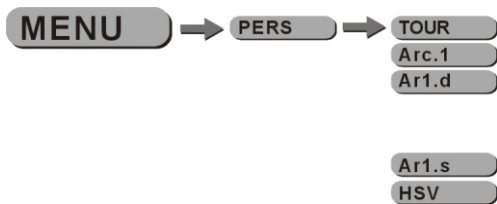

【PERSONALITY】

- Enter the **【PERSONALITY】** mode to select DMX mode: **【TOUR】** , **【Arc.1】** , **【Ar1.d】** , **【Ar1.s】** or **【HSV】** .

3.8 ID ADDRESS



【ID】

- Enter the **【ID】** mode to set the ID ADDRESS.

3.9 EDITING CUSTOM PROGRAMS

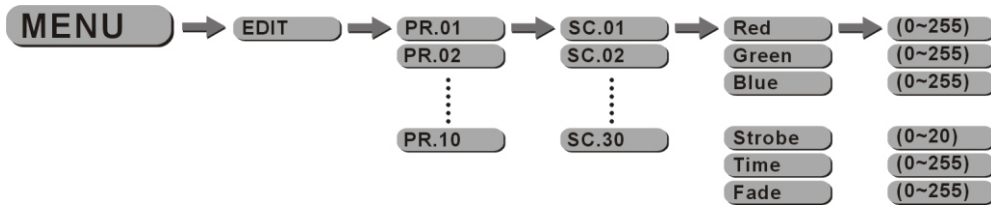

【EDIT CUSTOM】

- Enter the **【EDIT】** mode to edit the custom programs **【PR.01】** to **【PR.10】** .
- Each custom program has 30 steps that can be edited.
- Each step allows the creation of a scene using RED **【Red】** , GREEN **【Green】** , BLUE **【Blue】** , STROBE **【Strobe】** , TIME **【Time】** & FADE **【Fade】** .

3.10 SPECIAL SETTINGS

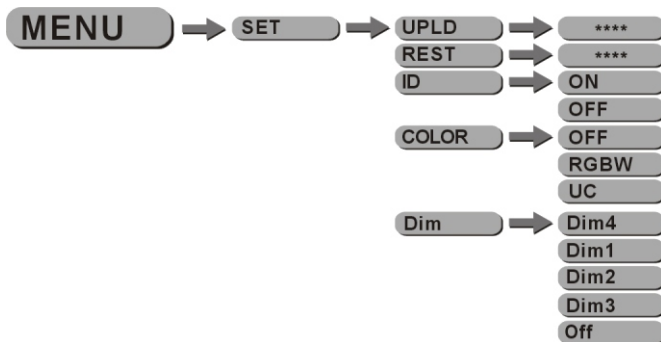

【SETTING】

- Select **【UPLD】** to upload the custom programs from the current MASTER unit to the SLAVE units.
- In order to activate the upload function the password must be entered.
- Password is the same as the main access password.
- When uploading the MASTER and SLAVE units will display YELLOW.
- If an error occurs when uploading the MASTER and/or SLAVE units will display RED.
- On successful uploading of the custom programs the MASTER and SLAVE units will display GREEN.
- In order to reset custom modes to default values select **【REST】** .
- Enter **【ID】** in order to allow/disallow ID address function from the DMX512 controller.
- **【COLOR】** is for activate/unactivate the color calibration functions.

When **【RGBW】** is selected, on RGB = 255,255,255, the color is displayed as calibrated in CAL2 -- RGBW. When **【COLOR】** is set **【OFF】** , on RGB = 255,255,255, the RGB values are not adjusted and the output is most powerful.

When **【UC】** is selected, the RGB output are adjusted to a standard preset universal color which balances fixtures from different generations..

- Enter **【Dim】** to select dimmer mode and dimmer speed. When DIMMER is set to **【Off】**, then RGBW and MASTER DIMMER are linear. The Dim 1/2/3/4 are speed modes of the non linear dimmer, **【Dim1】** is the faster, while **【Dim4】** is the slowest. The factory default setting is **【Dim4】**.

3.11 WHITES CALIBRATION

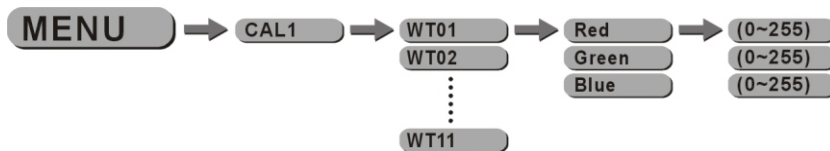

【CAL1】

- Enter the **【CAL1】** to select white color of different color temperature.
- There are 11 pre-programmed White colors can be edited by using **【Red】**, **【Green】** & **【Blue】**

3.12 RGB CALIBRATION



【CAL2】

- Enter the **【CAL2】** to adjust the RGB parameter to make different whites.
- When the new setting is activated, the DMX controller choose RGB = 255,255,255, the white color will be made by the actual RGB values on the **【CAL2】**.

3.13 ACTIVATE THE PASSWORD



【KEY】

- Enter the **【KEY】** mode to select whether the access password is on or off.
- When the fixture is set as PASS **【ON】**, after 30 seconds or turn on the fixture next time, the fixture will need an access password to enter the display menu control.

Note: The factory access password is **【UP】** + **【DOWN】** + **【UP】** + **【DOWN】**, then press **【ENTER】** to confirm the access.

4 USING A DMX512 CONTROLLER

4.1 BASIC ADDRESSING

- Connect all of the units in series using standard DMX512 signal cable or the IP65 rated cable provided.
- Set the DMX512 address in the **【DMX】** menu.
- It is possible to have the same DMX address or independent addresses for each fixture.

4.2 CHANNEL ASSIGNMENT

- Note: This product has three DMX512 channel configurations: **【TOUR】**, **【Arc.1】**, **【Ar1.d】**, **【Ar1.s】** and **【HSV】**

TOUR

CHANNEL	VALUE	FUNCTION
1	0 ↔ 255	MASTER DIMMER
2	0 ↔ 255	RED (or STEP TIME when CUS.01-CUS.10 in CH8 is activated)
3	0 ↔ 255	GREEN (or FADE TIME when CUS.01-CUS.10 in CH8 is activated)
4	0 ↔ 255	BLUE
5	0 ↔ 5	COLOR MACRO NO FUNCTION
	11 ↔ 30	RED100%/GREEN UP/BLUE0%
	31 ↔ 50	RED DOWN/GREEN 100%/BLUE0%
	51 ↔ 70	RED 0%/GREEN 100%/BLUE UP
	71 ↔ 90	RED 0%/GREEN DOWN/BLUE 100%
	91 ↔ 110	RED UP/GREEN 0%/BLUE100%
	111 ↔ 130	RED100%/GREEN 0%/BLUE DOWN
	131 ↔ 150	RED100%/GREEN UP/BLUE UP
	151 ↔ 170	RED DOWN/GREEN DOWN/BLUE 100%
	171 ↔ 200	RED100%/GREEN 100%/BLUE100%/WHITE 100%
	201 ↔ 205	WHITE1: 3200K
	206 ↔ 210	WHITE2: 3400K
	211 ↔ 215	WHITE3: 4200K
	216 ↔ 220	WHITE4: 4900K
221 ↔ 225	WHITE5: 5600K	
226 ↔ 230	WHITE6: 5900K	

CHANNEL	VALUE	FUNCTION
5	231↔235	WHITE 7: 6500K
	236↔240	WHITE 8: 7200K
	241↔245	WHITE 9: 8000K
	246↔250	WHITE 10: 8500K
	251↔255	WHITE 11: 10000K
6		STROBE
	0↔10	NO FUNCTION
	11↔255	1~20Hz
7		AUTO
	0↔20	NO FUNCTION
	21↔30	AUTO 1
	31↔40	AUTO 2
	41↔50	AUTO 3
	51↔60	AUTO 4
	61↔70	AUTO 5
	71↔80	AUTO 6
	81↔90	AUTO 7
	91↔100	AUTO 8
	101↔110	AUTO 9
	111↔120	AUTO 10
	121↔130	CUSTOM 1
	131↔140	CUSTOM 2
	141↔150	CUSTOM 3
	151↔160	CUSTOM 4
	161↔170	CUSTOM 5
	171↔180	CUSTOM 6
	181↔190	CUSTOM 7
	191↔200	CUSTOM 8
201↔210	CUSTOM 9	
211↔220	CUSTOM 10	
221↔255	NO FUNCTION	
8	0↔255	AUTO SPEED ADJUSTMENT When using CH7,AUTO01-AUTO10, this function activated
9		DIMMER SPEED
	0↔9	PRESET DIMMER SPEED FROM DISPLAY MENU
	10↔29	LINEAR DIMMER
	30↔69	NON LINEAR DIMMER 1 (fastest)
	70↔129	NON LINEAR DIMMER 2
	130↔189	NON LINEAR DIMMER 3
190↔255	NON LINEAR DIMMER 4 (slowest)	
10		ID ADDRESS
	0↔9	ID1~ID66
	10↔19	ID1
	20↔29	ID2
	30↔39	ID3
	40↔49	ID4
50↔59	ID5	

CHANNEL	VALUE	FUNCTION	
10	60 ↔ 69	ID6	
	70 ↔ 79	ID7	
	80 ↔ 89	ID8	
	90 ↔ 99	ID9	
	100 ↔ 109	ID10	
	110 ↔ 119	ID11	
	120 ↔ 129	ID12	
	130 ↔ 139	ID13	
	140 ↔ 149	ID14	
	150 ↔ 159	ID15	
	160 ↔ 169	ID16	
	170 ↔ 179	ID17	
	180 ↔ 189	ID18	
	190 ↔ 199	ID19	
	200 ↔ 209	ID20	
	210	ID21	
	211	ID22	
	• • • • •	• • • • •	
	254	ID65	
	255	ID66	

Arc.1

CHANNEL	VALUE	FUNCTION
1	0 ↔ 255	RED
2	0 ↔ 255	GREEN
3	0 ↔ 255	BLUE

Ar1.d

CHANNEL	VALUE	FUNCTION
1	0 ↔ 255	MASTER DIMMER
2	0 ↔ 255	RED
3	0 ↔ 255	GREEN
4	0 ↔ 255	BLUE

Ar1.S

CHANNEL	VALUE	FUNCTION
1	0 ↔ 255	MASTER DIMMER
2	0 ↔ 255	RED
3	0 ↔ 255	GREEN
4	0 ↔ 255	BLUE
5	0 ↔ 255	STORE

HSV

CHANNEL	VALUE	FUNCTION
1	0 ↔ 255	HUE(0~100%)
2	0 ↔ 255	SATURATION(0~100%)
3	0 ↔ 255	VALUE(0~100%)

4.3 BASIC INSTRUCTIONS FOR DMX512 OPERATION (TOUR)

MASTER DIMMER

- CH1 controls the intensity of the currently projected color
- When the slider is at the highest position (255) the intensity of the output is the maximum

RED, GREEN & BLUE COLOR SELECTION

- CH2, CH3 & CH4 control the intensity ratio of each of the RED, GREEN, BLUE & WHITE LEDs.
- When the slider is at the highest position (255) the intensity of the color is the maximum.
- CH2, CH3, CH4 can be combined together to create over 16 million colors.

COLOR MACROS

- CH5 selects the required COLOR MACRO
- CH5 has priority over CH2, CH3, CH4 & CH5
- CH1 is used to control the intensity of the COLOR MACRO

STROBE

- CH 6 controls the strobe of CH1 to Ch5

ID ADDRESS SELECTION

- CH10 is used to select the target ID address.
- Each independent DMX address may have upto 66 independent ID addresses.
- An ID address of 0 will activate all ID address locations.

AUTO

- CH7 selects the preset AUTO programs AT.01-AT.10 or the custom AUTO programs CUS.01-CUS.10
- When activating the custom AUTO programs CUS.01 to CUS.10 then it is possible to control the STEP TIME and FADE TIME using CH2 and CH3 respectively.
- CH7 has priority over CH2, CH3, CH4, CH5, CH6.

DIMMER SPEED

- Ch9 is for selecting the dimmer mode and dimmer speed. When DIMMER is set to **【Off】**, then RGBW and MASTER DIMMER are linear. The Dim 1/2/3/4 are different speed of the non linear dimmer .

5 APPENDIX

5.1 TROUBLE SHOOTING

SITUATION	CAUSE	ACTION
No display	1) No power input 2) Power connection error 3) Display damaged 4) Display board IC error, or power input connection error, or two board connection error 5) Contrast decay	1) Check power supply 2) Check power connection 3) Replace display 4) Check the IC and all the connections 5) Adjust the LCD contrast
LED MODULE on, but no control from display	1) Display IC reverse install 2) Display IC damaged	1) Check Display IC installation and quality
Display normal, but no response from buttons	1) Buttons damaged 2) Display IC damaged	1) Replace buttons 2) Replace Display IC
No DMX signal	1) Signal Cable error 2) Signal connection error 3) The DMX signal receive IC damaged 4) DMX address error	1) Check all signal Cables 2) Check all signal connections 3) Check the DMX signal receive IC 4) Check DMX address
When the surface temperature of the unit exceeds 75°C, the temperature protection no work.	1) The heat sensor resistance of LED board error 2) The temperature protection circuit on the display error.	1) Replace the heat sensor resistance. 2) Check the temperature protection circuit.
Color mixing uneven, with splash	1) LED not joining well 2) Lens not installing well	1) Check LEDs joining 2) Check lens installing
Partial color (partial red, partial green, partial blue or partial white)	1) The current of one of the color group LEDs is too strong or too weak. 2) LED brightness not enough	1) Check driver current of the partial color LEDs on the Driver PCB 2) Check LED quality 3) Reset to factory default setting.
LEDs of the same color are not lit	1) LED damaged 2) LED damaged or Main PCB	1) Replace LEDs 2) Replace damaged LED or Main PCB
Manual and program can not save	1) Saving IC damaged	1) Replace saving IC

5.2 MAINTENANCE

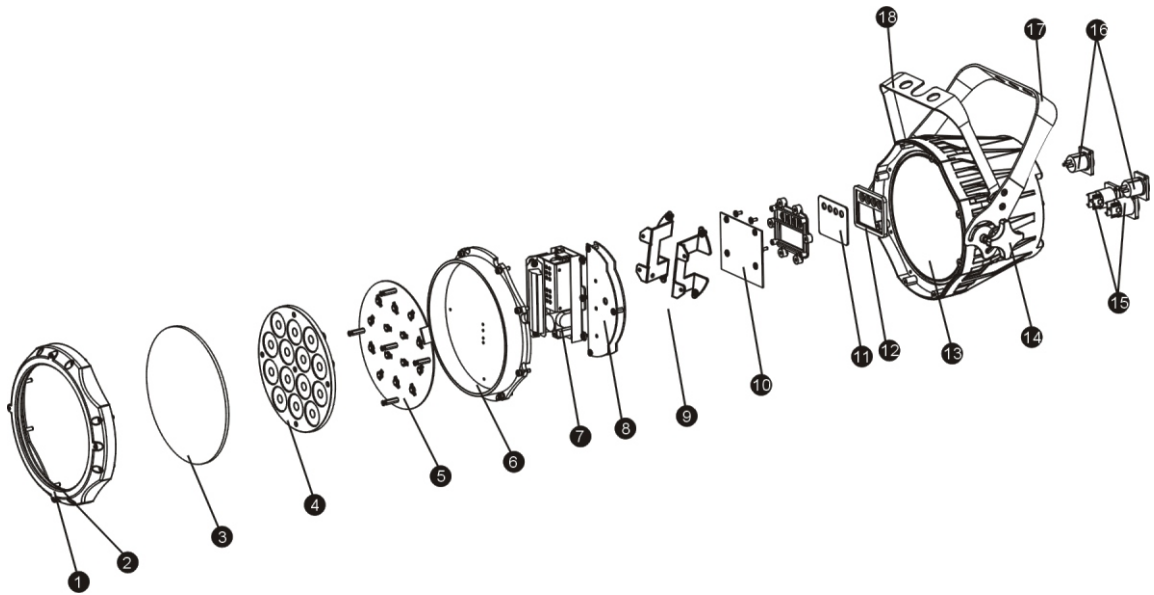

No	ITEM	No	ITEM
1	Front cover	10	Display PCB
2	Rubber seal	11	Display clear plate
3	Clear glass	12	Button seal
4	Lens completed set	13	Casing
5	LED PCB	14	Adjusting stainless steel knob
6	Heat sink	15	Power cable socket
7	Power supply	16	DMX cable socket
8	Driver PCB	17	Main support
9	Power connection board	18	Secondary support